

Original

Installation and service instruction

Pneumatic cylinder type EC and ECS for knife gate valves

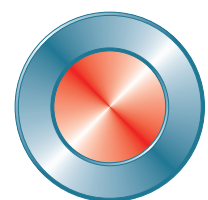

Stafsjö
SINCE 1666

Original installation and service instruction

Products: Pneumatic cylinder type EC and ECS for knife gate valves

Table of contents

A) General	2
A1 Symbols	2
A2 Pneumatic cylinder destination.....	2
A3 Related documents	3
A4 Cylinder marking	3
A5 Transport, storage and handling	4
Transport:.....	4
Handling and storage:	4
A6 Air connections.....	5
B) Installation, functional check and disassembling	5
B1 Safety warnings at installation.....	5
B2 Conditions for combination valve and cylinder	6
B3 Installation on the knife gate valve	6
Mounting of single acting cylinder to a knife gate valve	6
Mounting of cylinder with adjustable gate clevis to a knife gate valve	7
B4 Adjusting cylinder stroke length.....	7
B5 Installation of the cylinder/knife gate valve unit into the pipe system	8
B6 Support of the cylinder	8
B7 Checklist at end of Installation of the cylinder/knife gate valve unit into the pipe system	8
B8 Installation in an ATEX-classified area.....	9
B9 Disassembling.....	9
Disassembling the cylinder from the knife gate valve.....	9
Disassembling of the cylinder	10
C) Service and maintenance	10
C1 Safety warnings at service and maintenance	11
C2 Service	11
C3 Maintenance	11
C4 Troubleshooting	11
Declaration in compliance with EU-Directives	13



A) General

In this instruction a “Pneumatic cylinder for knife gate valves” is denominated shortly “cylinder” or “double acting EC and single acting ECS-O/C.

The instruction of a knife gate valve to which this cylinder is installed on, applies with priority. Instructions for the accessories, if any, should be observed.

A1 Symbols

In this instruction notes and warnings are written with symbols:

 XXXXX	Danger / Warning Points out a dangerous situation which may cause personal injuries or death.
	Advice Has to be respected.
	Information Information useful to follow.

If these notes and warnings are not respected by the user, dangerous situations may occur and may invalidate the warranty of the manufacturer.

A2 Pneumatic cylinder destination

Pneumatic cylinders (double- and single-acting) **type EC and ECS** are destined to operate a knife gate valve between its end positions with a signal from the plant control system:

- After connection of the accessory for compressed air supply and exhaust (i.e. solenoid valve or other device), with compressed air, maximum 10 bar, (see cylinder marking)
- At admissible cylinder temperature limits between -20°C and +80°C. Other temperature on request.

An (optional) positioner can operate the valve into any intermediate position between OPEN and CLOSED

The compressed air shall have a dew point equal to -20 °C or, at least, 10 °C below the ambient temperature (ISO 8573 Part 1, Class 3). The air shall be dry or slightly oil misted.

	Solenoid valves usually need a filter with a mesh width of 40 µm (ISO 8573-1, Class 5).
---	--

Single-acting pneumatic cylinders with integrated spring **Type ECS100 O/C – ECS320 O/C** additionally have

- A fail safe-function with spring return closing (ECS-C) or spring return opening (ECS-O) at interruption or fail of the air supply.

Note 1:

Knife gate valves supplied from Stafsjö with cylinder including a solenoid valve will close, if the customer has not specified otherwise, at electrical signal supply interruption.

Knife gate valves supplied from Stafsjö with cylinder fail-safe function with spring return open, including a solenoid valve shall open, at electrical signal supply interruption

Note 2:

The surrounding environment and the system in which the cylinder is installed shall have normal conditions, for its specification, to obtain the optimal lifetime of the valve and its pneumatic cylinder.

	Stafsjö does not accept any responsibility for the product, if the cylinder is modified or if wear part not approved by Stafsjö are used on the cylinder
---	--

A3 Related documents

For a cylinder assembled to a knife gate valve:

Further information on Stafsjö's valves and cylinders can be found on www.stafsjo.com:

ds+valve type (i.e. ds-MV) = Datasheet Valve with technical information (dimensions, material specification etc.)

mi+valve type (i.e. mi-MV) = Specific details for maintenance for each valve type.

sp+valve type (i.e. sp-MV) = Specific details for spare parts for each valve type.

act-cylinder type (i.e. act-EC)= Datasheet for cylinder with technical information.

sp+cylinder EC-type (i.e sp-EC)= Specific details for spare parts for each cylinder type.

A4 Cylinder marking

The marking shall not be damaged, covered or removed. Each pneumatic cylinder is marked as follows:

Double-acting

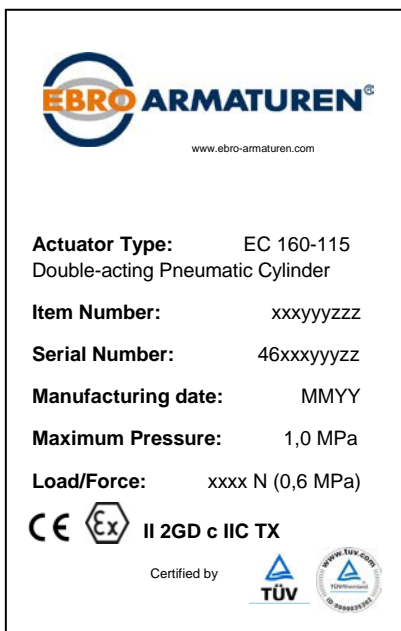

— Depending on version and size (diameter and stroke)
 — Depending on version (double- or single-acting)

— Month and Year, i.e. "0312" (march 2012)

— Max. allowed air pressure (1,0 MPa = 10 bar)

— Load/Force (at supply pressure)

— See next page for explanation of the ATEX marking.

Single-acting

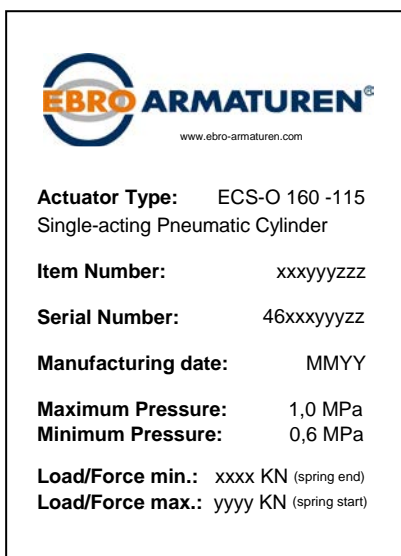

— Depending on version and size (diameter and stroke)
 — Depending on version (double- or single-acting)

— Month and Year ie "0312" (march 2012)

— Max. allowed air pressure (1,0 MPa = 10 bar)

— Min. necessary pressure (depending on spring)

— Min. spring force (end)

— Max. spring force (start)

ATEX marking: II 2GD c IIC TX

Group II: explosive atmosphere other than mine

Category 2: comprises equipment designed to function in conformity with the operational parameters established by the manufacturer that also ensure a high level of protection. Equipment in this category is intended for use in areas in which explosive atmospheres caused by gases, vapours, mists, or air/dust mixtures are likely to occur.

G: Gas

D: Dust

c: Type of protection: constructive (EN 13463-5)

IIC: Type of gas

TX: Maximum surface temperature. The actual maximum surface temperature depends on operating conditions (fluid in the valve) and surrounding environment. The user must consider the fluid parameters and surrounding environment before the actuator is installed.



In any contact with Stafsjö please refer to the article- and serial number stated on the label

A5 Transport, storage and handling



A cylinder supplied assembled to a knife gate valve:

Observe the original installation and service instructions for the knife gate valve.

Transport



A cylinder delivered separately:

Stafsjö's cylinder is packed according to the conditions of delivery. Damage can occur to the goods due to mishandling at transport. It is important to make a visual inspection of the goods at arrival. If transport damages are detected a report has to be written to the transportation company.

Handling and storage

Any lifting and handling shall be carried out with soft straps. The soft straps shall be placed and fastened around the cylinder – see Figure 1.



- Never fix lifting equipment at an accessory, the cylinder's tie rods or piston rod.
- Specifically note that threaded hole on top of the cylinder is only for use when handling the cylinder itself. When doing so, be sure to secure that all lifting regulations are considered.

At lifting and transport respect the weight of the cylinder, which is stated in the datasheet and make sure:

- That the soft straps do not risk to slide along the cylinder.
- That the cylinder and specifically mounted accessory are not exposed to blows or thrusts.
- That the cylinder at dispose is not applied to an accessory.

A pneumatic cylinder and its accessories shall be stored in a clean and dry environment, protected against dirt, dust and other pollution. It should not be exposed to direct sunlight.

Figure 1 Fastening by straps

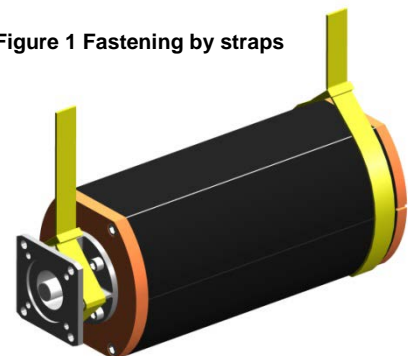

A6 Air connections

The air connections on the pneumatic cylinder have interface according Namur VDI/DE 3845 and pipe threads according to ISO 228-1:



Cylinder size	Connection	Air pipe dimension *)
EC 100 - EC 125	G ¼"	6 mm
EC 160	G ¼"	10 mm
EC 200	G ½"	12 mm
EC 250-320	G ½"	15 mm

*) This (inside) size shall be larger in case of very long piping

Table 2 Cylinder air supply dimension

Use proper sealing when the air connections are screwed onto the cylinder.



The air supply pipe connected to the pneumatic cylinder must have at least the same size as the connection in the cylinder. If the air supply pipe is too small it will throttle the air flow and may affect the function.

	<p>Single acting cylinders need only one air supply connection: Spring to open: Air connection at A, see figure 3 Spring to close: Air connection at B, see figure 3 The other cylinder air connection shall be closed by a filter to protect the cylinder inside from contamination at service.</p>
	<p>At air connection respect the requirements of pneumatic/electric accessories, if any.</p>

B) Installation, functional check and disassembling

	<p>This instruction includes safety recommendations for foreseeable risks at installation into a (pipe) system. It is the responsibility of the user to complete this instruction for system specific aspects. All requirements of the system shall be observed.</p>
---	--

B1 Safety warnings at installation

	<ul style="list-style-type: none"> • Installation shall be performed by qualified personal. Qualified are those persons who, due to experience, can judge the risk and execute the work correctly and who are able to detect and to eliminate possible risks. • After installation, the function of the pneumatic cylinder shall be in compliance with the 'Pneumatic cylinder Destination', see section A2. • For the cylinder the same safety instructions apply as for the air supply system and the control system to which the cylinder is connected. The respect of these requirements shall be followed. • The cylinder should not be exposed to external loads. In case of necessary support see section B6. • The cylinder and its accessories must be protected from any environment that may imply any risks to the function
 Danger	<ol style="list-style-type: none"> 1. Installation of a pneumatic cylinder on knife gate valve is only allowed if: <ul style="list-style-type: none"> • The knife gate valve is removed from the system or depressurised when installed. 2. A knife gate valve with cylinder shall be operated only if: <ul style="list-style-type: none"> • All gate guards are installed correctly. <p>The user's life and health is at stake if this is not followed. All other handling is the responsibility of the user.</p>
 Danger	<p>All work with single acting cylinder is subject to danger and extreme caution is required during installation. Make sure that all instructions described are followed and understood before any work with the cylinder begins. The user's life and health is at stake if this is not followed.</p>

B2 Conditions for combination valve and cylinder

!	Valve/ cylinder interfaces shall have identical dimensions. To assure this the customer must give all necessary information (i.e. valve type, DN) to Stafsjö at order.
! Warning	Due to safety requirements knife gate valve with a cylinder shall have all gate guards installed when it is operated. The user's life and health is at stake if this is not followed. These guards inhibit visual control of gate position. If control of the gate position is necessary, the beams are prepared for installation of electronic limit switches in both end positions.
! Warning	Do not remove the black caps on the beams without installing a limit switch.

B3 Installation on the knife gate valve

- Generally a Stafsjö's knife gate valve should be mounted in a horizontal pipe line with the cylinder in a vertical upright position. For any other cylinder position see section B6 <Support>
- The cylinder is delivered ready for installation on a Stafsjö's knife gate valve.
- When mounting a cylinder on Stafsjö's knife gate valve, the valve cannot be installed into the pipe line, in order to adjust the cylinder stroke correctly.
- Before installing the cylinder, ensure:
 - That the cylinder has correct stroke length and is correctly sized for the valve type
 - That the valve and cylinder interface is rectangular and correctly centred to the gate connection
 - That the compressed air quality conforms to section A2 <cylinder destination> and the air connection dimensions conforms to the cylinder capacity, see table in section A6
- Before mounting make sure that you have:
 - Clevis pin (20) and split pins (21) (see figure 3)
 - Correctly sized gate guards
 - Beams with holes to be able to loosen/fasten the cylinder from the gate
 - Compressed air, in order to operate the cylinder
 - For single acting, ECS O/C: an air regulator and a ball valve that are completely tight

Mounting of single acting cylinder (ECS – O/C) to a knife gate valve

! Warning	On single acting cylinder with spring return for closure (ECS-C), it's extremely important that extreme caution is taken during this moment and that the ECS-C is properly fastened and locked in a work bench. Make sure to use a tight air regulator and a ball valve when mounting the unit as described below.
--------------	--

Before mounting the cylinder on the valve, the piston rod must be moved to its top position. In order to do so follow the steps bellow:

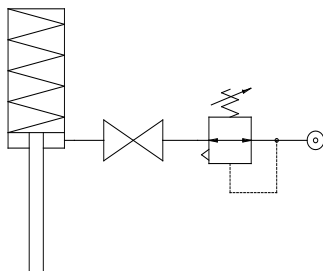

Figure 2
Connection of the air regulator and the ball valve
 ECS-O Air connection at A, see figure 3.
 ECS-C Air connection at B, see figure 3.

1. Connect the air supply to the air regulator. Make sure the ball valve is closed
2. Open the ball valve and operate the ECS with the air regulator.
3. *Only for ECS-C, spring return for closure.* Move the piston rod (25) to its top position and close the ball valve and make sure that there is no leakage.
4. Disconnect the air supply from the air regulator. The air regulator and the ball valve **shall not** be removed.
5. Then follow the steps according to adjustable gate clevis

Mounting of cylinder with adjustable gate clevis to a knife gate valve

Follow the steps below:

1. Make sure that the knife gate valve is in closed position.
2. Screw the locking nut (28) and gate clevis (17) on to half of the threaded part of the piston rod (25)
3. Put the cylinder at the valve interface
4. Attach the cylinder to the valve interface by manually tighten the four nuts. For double acting go to number 6
5. *For single acting, only.* Connect the air supply to the air regulator. Open the ball valve. Move the the piston rod (25) to the gate (6) by gently operating the air regulator. Go to number 7
6. *For double acting, only.* Connect the air supply and move the piston rod (25) toward the gate (8) by gently operating the cylinder
7. Make sure that the hole in the gate clevis (17) will interface with the hole in the gate and with the hole in the beam in order to attach the clevis pin (20).
8. Make sure that the cylinder is parallel to the gate and at right angles to the beams
9. Fasten the gate clevis (17) to the gate with the clevis pin (20) and the split pins (21).
10. Tighten the cylinder at the interface to the beams with the four nuts
Fasten evenly and crosswise while holding the beams together
11. Leave an EC and ECS-C in closed position. Leave an ECS-O in opened position by evacuating the air in the air regulator

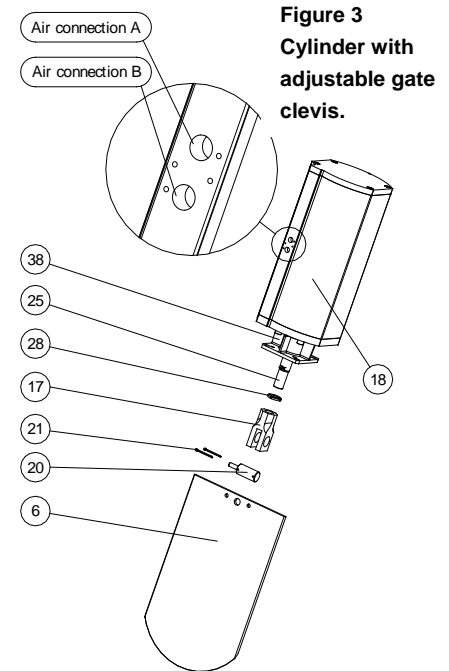



Figure 3
Cylinder with adjustable gate clevis.

B4 Adjusting cylinder stroke length

Make sure that the cylinder is correctly mounted on the valve (see section B3)

 Danger	<p>For single acting cylinder type ECS-C (spring return for closure): Under no circumstances is it allowed to introduce fingers or other body parts in valve bore during this operation.</p>
--	--

For single acting cylinder, ECS, only:

Connect the air supply to the air regulator and Open the ball valve, see figure 2

All cylinders:

1. Open the knife gate valve by gently operating the cylinder. The piston rod (25) must be in its top position in the cylinder. In this position, the gate should not have left the valve bore completely.
2. Measure the distance Y (see Figure 4) between the edges of the retainer ring in the valve body and the lowest part of the gate.
3. If $Y \neq 0$ mm, carefully close the knife gate valve.
If $Y=0$ go to step 6.

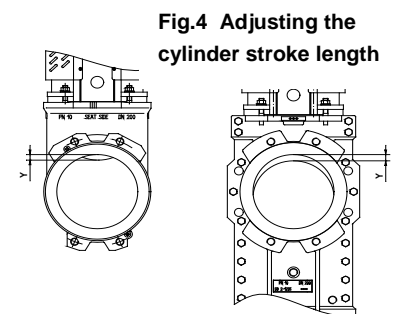



Fig.4 Adjusting the cylinder stroke length

 Danger	<p>For single acting cylinder type ECS-O and ECS-C: When adjusting the gate clevis make sure that the ball valve is completely closed (see figure 2)</p>
--	---

Dismount the split pins (21) and the clevis pin (20) to release the gate clevis (17) from the gate (6). Adjust the gate clevis (17) on the piston rod (25) by screwing the gate clevis according the distance Y. Lock it with the locking nut (28)

4. Connect the gate to the piston rod, close the valve (100%) smoothly and re-open the cylinder to the full OPEN cylinder position. Check the overlap Y (see Figure 4).
5. After adjusting, the lowest part of the gate shall be at minimum edge-to-edge with the retainer ring ($Y=0$ mm) for a completely open valve – if not repeat the procedure to adjust the clevis setting. The seat might be damaged at closure if the gate is too far into the knife gate valve (the gate must not go off the seat). If the gate is partly in the knife gate valve bore, it will throttle the media flow which might cause erosion and damage the seat.

6. Install the gate guards and fasten the guard screws for durable protection, observe warnings in clause B2.



These gate guards shall cover a full knife gate valve stroke:

At any doubt, check the valve serial number (see valve nameplate) and ask Stafsjö Valves for support.

7. For double acting EC: disconnect the air supply. If double acting cylinders go to point 9.
8. For single acting cylinder, ECS-C and ECS-O, only:
- Operate the knife gate valve equipped with ECS-O (fail safe opened) into totally open position before the air supply is disconnected.
Disconnect the air supply
 - Operate the knife gate valve equipped with ECS-C (fail safe closed) into totally closed position before the air supply is disconnected.
Disconnect the air supply
9. Pull out the black caps to install the electronic limit switches (if any). Observe the manufacturer's instruction for electric connection.



Danger

If no limit switches are installed the two black caps shall, in any case, remain in place – due to risk of personel injuries!

B5 Installation of the cylinder/knife gate valve unit into the pipe system



For the knife gate valve installation follow the instructions given in the Original valve installation and service instructions.

- Connect the cylinder and accessories, if any, to the air supply and control system. For correct air connection see A6. Follow the relevant accessory instruction, if any.

B6 Support of the cylinder

Stafsjö's knife gate valve should be mounted in a horizontal pipe line with the cylinder in a vertical upright position. If the knife gate valve is mounted in any other direction, the dead weight of a long gate or a large cylinder may cause tensions in the valve body and affect the valve tightness and function. Valve/cylinder unit that are exposed to vibrations or other mechanical stresses can be subject to similar deformations. The knife gate valve and its cylinder should be supported in these cases.



Support of the cylinder can preferably be done by mounting supporting device at the tie rods, see figure 5.

B7 Checklist at end of Installation of the cylinder/knife gate valve unit into the pipe system

Following should be checked before start up:

1. Is the air supply pressure sufficient?
At the cylinder air connection, the pressure should conform to the values given in the data sheet. The air supply pressure shall remain in the limit of the cylinder marking.
2. Is the air supply piping sufficient?
Check that the air supply to the cylinder has the right size and is correctly installed according to section A6

Note:

A smooth valve gate operation during service indicates a sufficient air supply.

3. Is the knife gate valve stroke adjusted correctly?
The valve shall move between the 100% open or close positions by the relevant signal of the control system. Adjusting of cylinder stroke length is described in section B4

4. Is the solenoid valve (or any other relevant device), connected correctly?

- The knife gate valve shall be completely opened or closed by the relevant signal of the control system.
- At correct air supply pressure, but at interruption of the electric signal at the solenoid valve (for a test disconnect the cable!) the knife gate valve should operate as follows:

Cylinder type	Action
Double acting	If not otherwise specified by the customer: The knife gate valve shall close
Spring to failure close	The knife gate valve shall close
Spring to failure open	The knife gate valve shall open

5. Is the knife gate valve/cylinder interface bolting correctly fastened?

6. Check if a support according to section B6 may be necessary.

	Never operate a knife gate valve with actuator without the gate guards securely fastened!
---	--

At any trouble follow section C4.

B8 Installation in an ATEX-classified area

Note:

Additional requirements may be found in the knife gate valve's installation and service instruction

	In ATEX-classified zones, in accordance with ATEX Directive 94/9/EC, only knife gate valves with ATEX-classification and relevant valve marking shall be installed.
---	---

Additional to the requirements above make sure that:

- The cylinder is part of the plant earthed system,
- The user has performed a risk analysis of the pipe line and knife gate valve/cylinder unit in accordance with the guidelines of ATEX Directives.

B9 Disassembling



 Danger	<p>1. Disassembling a cylinder from a knife gate valve is only allowed if:</p> <ul style="list-style-type: none"> • The knife gate valve is depressurised, • The cylinder is disconnected from the air supply <p>2. Disassembling of a cylinder itself is only allowed if:</p> <ul style="list-style-type: none"> • The cylinder is disconnected from the air supply and from the knife gate valve. • NO disassembling of a single acting cylinder shall be made by the user, <p>The user's life and health is at stake if this is not followed.</p> <p>All other handling is the responsibility of the user.</p>
--	---

For the cylinder the same safety instructions apply as for the air supply system and for the control system to which the cylinder is connected. The respect of these requirements should be followed.

Disassembling the cylinder from the knife gate valve

All cylinders:

1. Depressurise the pipe line.

	If the complete unit cylinder/knife gate valve shall be disassembled from the pipe line follow the valve instruction.
	The valve shall not be pressurised until the valve is equipped with an actuator

Double acting EC:

2. Operate the valve into complete closed position. Make sure that the clevis pin is centered in the lowest hole of the beam. If the valve is equipped with switches, of any kind, this one has to be removed first
3. Depressurise and disconnect the air supply from the cylinder.
4. Disconnect all electric connections.
5. Disconnect the piston rod from the gate by removing the split pins and clevis pin.
6. Remove the cylinder from the valve interface by loosening the four nuts at the valve interface. Use soft straps if necessary, see section A5. Make sure not to damage any accessory.
7. At storage, observe section A5.

Single acting ECS-O/C (fail safe opened and fail safe closed):

1. Connect the air supply to the air regulator ball valve unit (see figure 2).
2. Operate the knife gate valve into complete closed position. Make sure that the clevis pin (20) is centered in the lowest hole of the beam. If the valve is equipped with switches, of any kind, this one has to be removed first
3. Close the ball valve
4. Disconnect all electric connections.
5. Disconnect the piston rod from the gate (6) by removing the split pins (21) and clevis pin (20).
6. Move the piston to the top (open) position in the cylinder, by gently operating the air regulator
7. Remove the cylinder from the valve interface by loosening the four nuts at the valve interface. Use soft straps if necessary, see section A5. Make sure not to damage any accessory.
8. Depressurise the cylinder by gently operating the air regulator to zero.



Danger

The piston rod for ECS-C (fail safe closed) will move to its unpressurised position (piston rod out). Make sure no hands or fingers are in the way of the piston rod movement

9. Disconnect the air regulator and ball valve unit
10. At storage, observe section A5.

Disassembling of the cylinder

For disassembling of the cylinder, see maintenance instructions for cylinders on www.stafsjo.com.



Danger

No disassembling shall be made of a single acting cylinder by the user. The user's life and health is at stake if this is not followed!

C) Service and maintenance

The user shall make a risk analysis as per Directive 2006/42/EC for the knife gate valve/cylinder system.

For this Stafsjö supplies following documents:

- This original installation and service instruction for the pneumatic cylinder
- The original installation and service instruction for the knife gate valve
- The manufactures declaration to EC Directives



Further information on the pneumatic cylinder types EC and ECS can be found on www.stafsjo.com, see section A3



This instruction includes safety notes for industrial application for any foreseeable risk at use of the cylinder.

It is the responsibility of the user/planner to complete these instructions, consider specific risks from the plant.

C1 Safety warnings at service and maintenance

	<ul style="list-style-type: none">• At service, function of the cylinder shall be in compliance with the cylinder destination, see section A2.• The use of the cylinder shall be in compliance with the cylinder markings in section A4.• Service and maintenance shall be performed by qualified personal. Qualified are those persons who, due to experience, can judge the risk and execute the work correctly and who are able to detect and to eliminate possible risks.• At maintenance of the cylinder it should be disassembled as described in section B9.• No repair shall be done on the cylinder when:<ul style="list-style-type: none">• the pipe system is pressurised and/or• the air supply system is pressurised.• At any start up, air supply and electric connections should be visually inspected, to be in order.
 Danger	<p>A valve with cylinder shall be operated only if:</p> <ul style="list-style-type: none">• All gate guards are installed correctly, so that the moving gate(s) is completely encapsulated. <p>If a fault or defect is detected at a single acting pneumatic cylinder:</p> <ul style="list-style-type: none">• No repair shall be made by the user himself. The cylinder contains a compressed repair spring. Repair on cylinder type ECS-O/C must always be made by EBRO or Stafsjö's personal or by Stafsjö appointed personal. <p>The user's life and health is at stake if this is not followed!</p>

C2 Service

Note:

For a cylinder assembled to a knife gate valve: additional requirements may be found in the knife gate valve installation and service instruction.

The start up can be made, if the cylinder has passed all checks according to section B7 <Checklist> without fail, the cylinder shall operate by the signals of the plant control system.

The cylinder should be inspected on regularly basis for leakage and other external effects that might involve risks for the operating personnel, the valve and its accessories.

A full operational test should be performed once a month to verify that the cylinder/knife gate valve unit functions correctly. If a fault or problem is detected at an inspection or operational test, a more thoroughly check and repair should be made as soon as possible. Further information on spare parts and/or instructions for maintenance is available on www.stafsjo.com.

C3 Maintenance

As long as the cylinder is tight the only maintenance is a visual control.

The lifetime of the wear parts in the cylinder depends on the frequency of the cylinder operation, quality of the air supply (i.e. pressure and temperature) and the surrounding environment.

Wear parts can be identified by the documents listed in the clause A3 to be downloaded by www.stafsjo.com.

C4 Troubleshooting

Note

For a cylinder mounted on a knife gate valve additional requirements may be found in the valve instruction.

Problem	Reason	Measure
Leakage in rod sealing	Worn-out rod sealing	See chapter C3 and maintenance instructions (MI-EC) for cylinder www.stafsjo.com
Leakage in cylinder end cup	Insufficient seal between cylinder tube and cylinder end cups	See chapter C3 and (MI-EC) for cylinder www.stafsjo.com
Gate does not open/close completely	Insufficient air supply to cylinder Wrongly adjusted cylinder stroke Fault in limit switches Clogged valve Damaged seat/gate Worn out piston sealing	See chapter A6 See chapter B4 See chapter B7 See Installation and service instruction for valve See chapter C3 and (MI-EC) for cylinder and valve www.stafsjo.com
Gate does not open/close in a smooth movement	Insufficient air supply to cylinder Clogged valve Damaged seat/gate Worn out piston sealing	See chapter B7 (checklist) See Installation and service instruction for valve See chapter C3 and (MI-EC) for cylinder and valve www.stafsjo.com

EBRO or Stafsjö can offer maintenance of the cylinders.

Please contact EBRO or Stafsjö or your local representative for further information.

Declaration in compliance with EU-Directives

The manufacturer **EBRO Armaturen Interantional Est Co KG, Eschen, Branch Office Cham, Gewerberstrasse 5, CH-6330 Cham Switzerland**, declares that Ebro's pneumatic cylinders **type double-acting (EC) and single-acting with spring return for open or close (ECS-O/C)** are manufactured in accordance with the requirements of the following standards:
ISO 228-1:2000 Pipe threads where pressure-tight joints are not made on the threads -- Part 1: Dimensions, tolerances and designation.

Product documents are available on the following:

Design documentation, Technical data sheets, catalogue pages

These products comply with the following directives:

Pressure Equipment Directive 97/23 EC (PED).

Applies for Art. 3 Paragraph 3

ATEX DIRECTIVE 94/9/CE (ATEX)  II 2 GD c IIC TX

Harmonised standard applied: EN 13463-1:2009

EN 13463-5:2011

TÜV Italia (0948) retains the technical documentation with receipt number TÜV IT 12 ATEX 014 AR

Machinery Directive 2006/42 EC (MD). This Directive does not apply:

The cylinder is no <machine> and no <incomplete machine> but only a <component> in the sense of the <Guide to the Machinery Directive 2006/42 EC, rev04/2010>, §34, it is destined to be installed onto a Stafsjö knife gate valve.

Stafsjö, 2013-01-22



EBRO ARMATUREN INTERNATIONAL
 Est. & Co. KG, Eschen
 Zweigniederlassung Cham
 Gewerberstrasse 5, Postfach 5059
 CH-6330 Cham

H. Hager / EBRO International General Manager

The following applies for the user:

1. The use of the cylinder shall comply with the <intended use>, defined in the "Installation and service instructions" (IS-CYLINDER) supplied with the cylinder. The user shall observe the warnings in this manual.
2. This is the "Installation Declaration" according to the "MD", together with the table below it lists some compliance of the cylinder design with the Directive above.
3. The valve/cylinder unit shall not be put into operation until the conformity to all applicable EU directives into which the unit is installed has been declared by the person responsible.
4. Stafsjö Valves AB has made and documented the required risk analysis, the EBRO employee responsible for this documentation is Dirk Schröder, E. A. Antriebstechnologie & Services GmbH, Karlstr.8, at 58135 Hagen Germany

Manufacturer EBRO Armaturen Interantional Est Co KG, Eschen, Branch Office Cham, Gewerberstrasse 5, CH-6330 Cham Switzerland declares that a EBRO – pneumatic cylinder for a knife gate valve complies with EC- Directives as follows:	
§ of Annex 1	Declared conformance to the requirements as per Annex 1 of the Directive 2006/42/EC
1.1.1.,g) Cylinder destination	See installation and service instruction
1.1.2.,c) foreseeable misuse	See installation and service instruction
1.1.2.,d) protecting measures personnel	Same as the pipe section into which the valve/cylinder unit is installed.
1.1.2.,e) accessories for maintenance	No special tools are necessary.
1.1.3 material in contact with compressed air	All cylinder material in contact with compressed air is chosen for air taken from clean and not corrosive environment. The relevant risk analysis is the responsibility of the user.
1.1.5 handling	See installation and service instruction
1.2 and 6.2.11 control system	Is the responsibility of the user in combination with the instruction of the cylinder.
1.3.2 withstand to stresses	For parts under pressure: See declaration of conformity to the PED 97/23/EC For functional parts: Ensured at contractual use of the cylinder.
1.3.4 sharp edges or angles	Requirements fulfilled.
1.3.7/8 risks related to moving parts	Requirements are fulfilled at use as per <valve destination> and <cylinder destination> of the valve/cylinder unit defined in the relevant instructions. Delivered gate guards must be installed on the valve. No maintenance or service is allowed when the pipe line is pressurized or the cylinder is under pressure from air supply. If the valve is modified by the customer (new cylinder): necessary protective devices shall be installed. Ask Stafsjö for support
1.5.1 – 1.5.3 energy supply	In the responsibility of the user in combination with the instruction of the cylinder
1.5.5 contact to surface with high/low temp.	In the responsibility of the user
1.5.7 explosion	 -protection may be necessary. This shall be confirmed in Stafsjö's order acknowledgement. Pay attention to the cylinder marking and relevant instruction from Stafsjö.
1.5.13 emission of dangerous substances	Not applicable at not dangerous fluids (compressed air).
1.6.1 maintenance	See installation and service instruction
1.7.3 marking	Cylinder: see Original installation and service instruction Knife gate valve: see Original installation and service instruction knife gate valve
1.7.4 service instruction	See I installation and service instruction and valve instruction.
Requirements from Annex III	The cylinder is no complete machine and no incomplete machine. No CE marking for conformity with the directive 2006/42/EC.
Requirements from Annexes IV,VIII to XI	Not applicable.

Stafsjö Valves AB
SE-618 95 Stavsjö
Sweden

Tel: +46 11 39 31 00
Fax: +46 11 39 30 67

info@stafsjo.se
www.stafsjo.com